



 **大连奇耘电子有限公司**  
DALIAN QIYUN DISPLAY CO., LTD.

**确认此型号所有图纸;签字确认:**

DESIGNED BY: <b>LJF</b>	<b>GDC8310C2P7V3B</b>	VERSION: 1.0 NO. 1 OF 4	1. DISPLAY TYPE: TN/POSITIVE	6. POLARIZER TYPE: TRANSFLECTIVE	VERSION	REVISION RECORD
CHECKED BY: <b>TANG</b>	 	UNIT: mm DATE: 2020-05-19	2. OPERATING VOLTAGE: 3.3V	7. VIEWING DIRECTION: 6:00	1.0	初版
TOLERANCES UNLESS OTHERWISE SPECIFIED: ±0.2			3. DRIVE MODE: 1/4D, 1/3B	8. CONNECTOR: PIN	2.0	
			4. OPERATING TEMP: 0°C~50°C	9. CUSTOMER NO:	3.0	
			5. STORAGE TEMP: -10°C~60°C	10. LCM NO:	4.0	

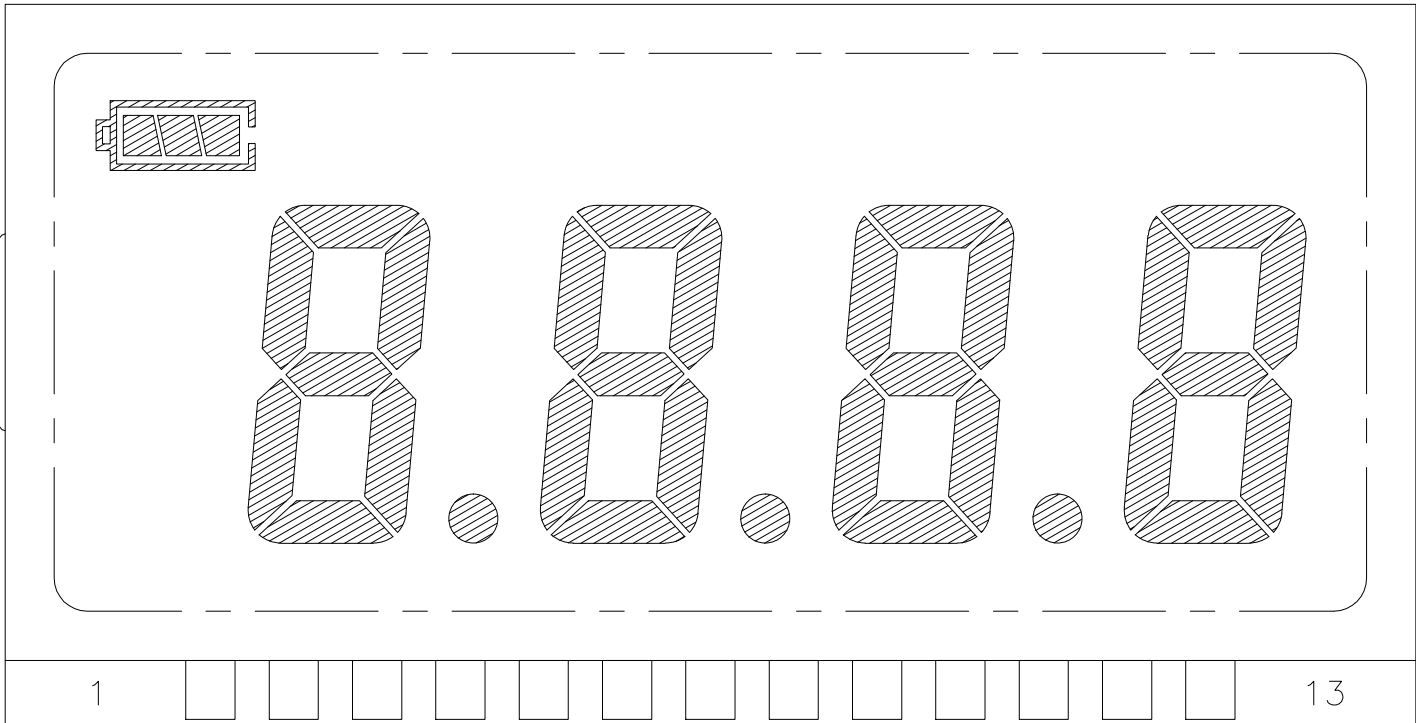

**大连奇耘电子有限公司**  
DALIAN QIYUN DISPLAY CO., LTD.

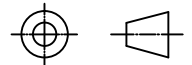

DESIGNED BY: <b>LJF</b>	<b>GDC8310C2P7V3B</b>	VERSION: 1.0 NO. 2 OF 4
CHECKED BY: <b>TANG</b>		UNIT: mm DATE: 2020-05-19
TOLERANCES UNLESS OTHERWISE SPECIFIED: ±0.2		

# 全显示效果图

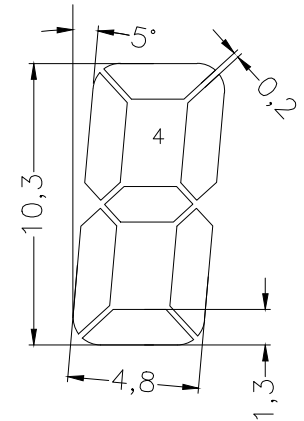
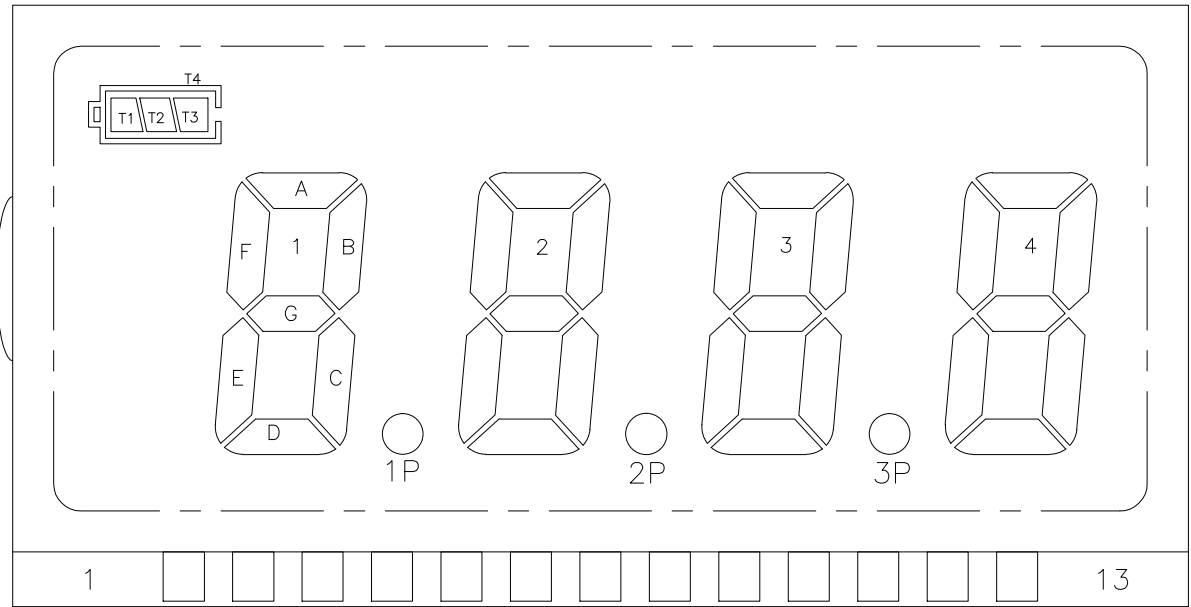
PIN	1	2	3	4	5	6	7	8	9	10	11	12	13
COM0				COM0	1D	1P	2D	2P	3D	3P	4D		T2
COM1			COM1		1E	1C	2E	2C	3E	3C	4E	4C	T3
COM2		COM2			1F	1G	2F	2G	3F	3G	4F	4G	T1
COM3	COM3				1A	1B	2A	2B	3A	3B	4A	4B	T4



 **大连奇耘电子有限公司**  
DALIAN QIYUN DISPLAY CO., LTD.

DESIGNED BY: <b>LJF</b>	<b>GDC8310C2P7V3B</b>	VERSION: 1.0 NO. 3 OF 4
CHECKED BY: <b>TANG</b>	 	UNIT: mm DATE: 2020-05-19
TOLERANCES UNLESS OTHERWISE SPECIFIED: ±0.2		

(1-4)

SEG

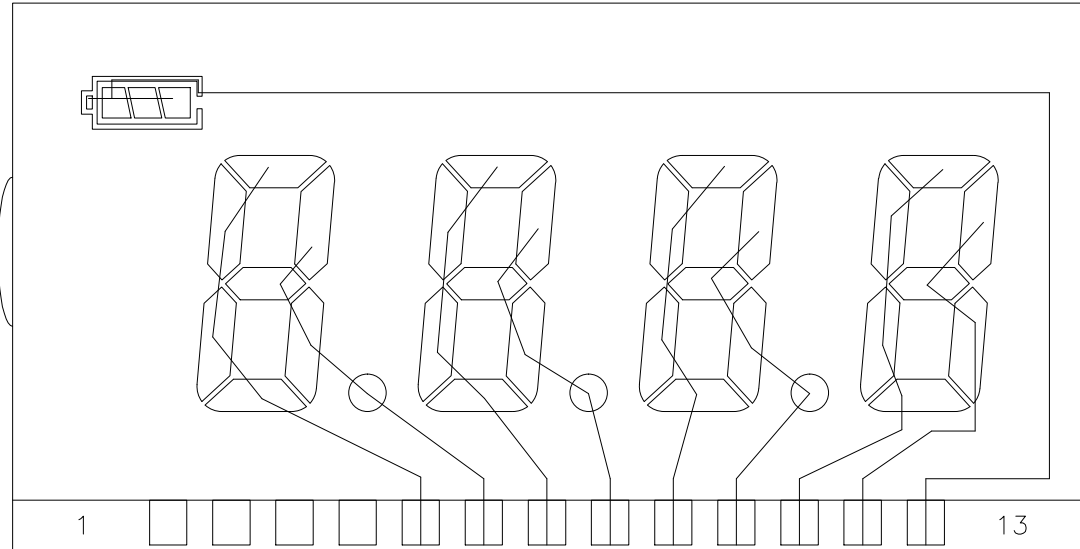

COM

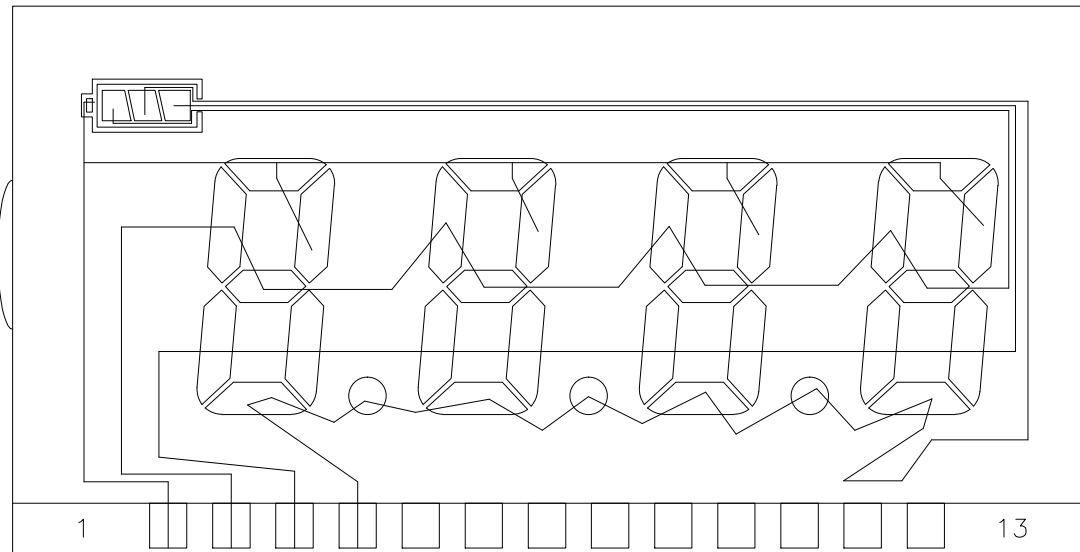

大连奇耘电子有限公司  
DALIAN QIYUN DISPLAY CO., LTD.

DESIGNED BY:

LJF

GDC8310C2P7V3B

VERSION: 1.0

NO. 4 OF 4

CHECKED BY:

TANG

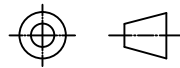

UNIT: mm

DATE: 2020-05-19

TOLERANCES UNLESS OTHERWISE SPECIFIED:  $\pm 0.2$