

大连奇耘电子有限公司  
DALIAN QIYUN DISPLAY CO., LTD.

确认此型号所有图纸;签字确认:

DESIGNED BY: <b>WCL</b>	<b>GDC130S(T)P8V3B</b>	VERSION: 1.0 NO. 1 OF 4	1. DISPLAY TYPE: TN/POSITIVE	2. OPERATING VOLTAGE: 3.0V	3. DRIVE MODE: 1/4DUTY,1/3BIAS	4. OPERATING TEMP: -40°C~80°C	5. STORAGE TEMP: -40°C~80°C	6. POLARIZER TYPE: TRANSLLECTIVE	7. VIEWING DIRECTION: 6:00	8. CONNECTOR: PIN	9. CUSTOMER NO:	VERSION: 1.0 2.0 3.0 4.0	REVISION RECORD 初版
CHECKED BY: <b>HQM</b>		UNIT: mm DATE: 2016-03-10											
TOLERANCES UNLESS OTHERWISE SPECIFIED:±0.2													

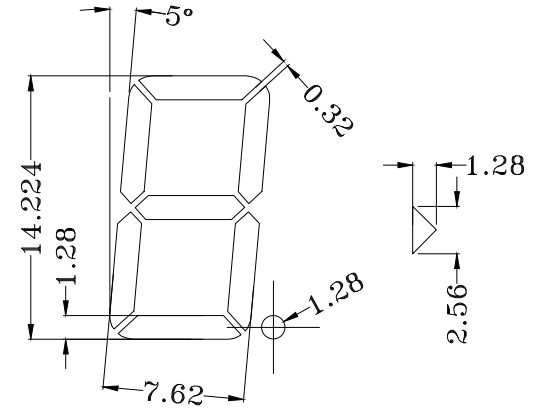
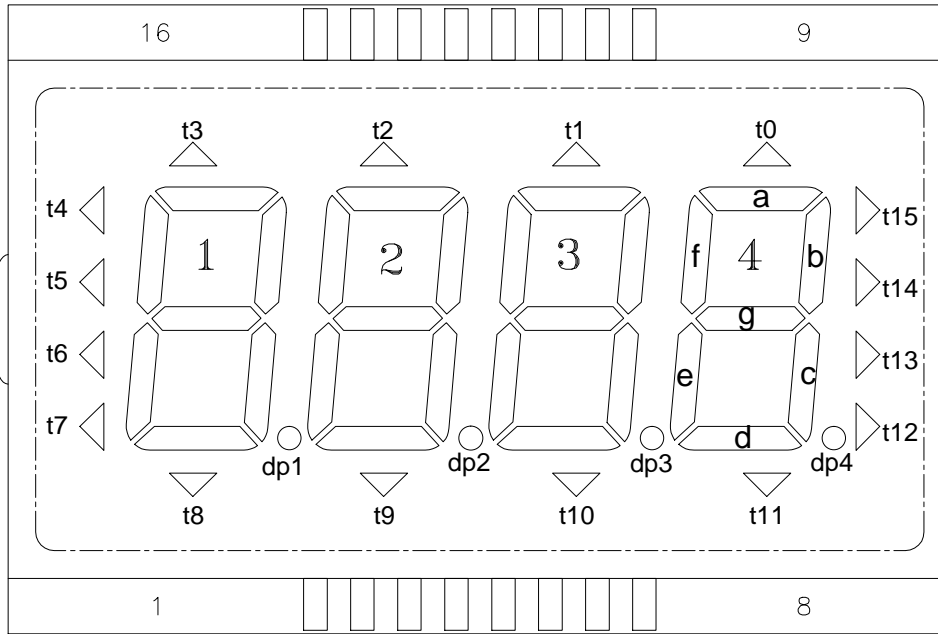

PIN	1	2	3	4	5	6	7	8	9	10	11	12	13	14	15	16
COM0	t3	t7	t8	t12	COM0				dp4	d4	dp3	d3	dp2	d2	dp1	d1
COM1	t2	t6	t9	t13		COM1			c4	e4	c3	e3	c2	e2	c1	e1
COM2	t1	t5	t10	t14			COM2		b4	g4	b3	g3	b2	g2	b1	g1
COM3	t0	t4	t11	t15				COM3	a4	f4	a3	f3	a2	f2	a1	f1



大连奇耘电子有限公司  
DALIAN QIYUN DISPLAY CO., LTD.

DESIGNED BY:

WCL

GDC130S(T)P8V3B

VERSION: 1.0

NO. 2 OF 4

CHECKED BY:

HQM

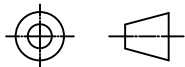

UNIT: mm

DATE: 2016-03-10

TOLERANCES UNLESS OTHERWISE SPECIFIED: ±0.2

SEG

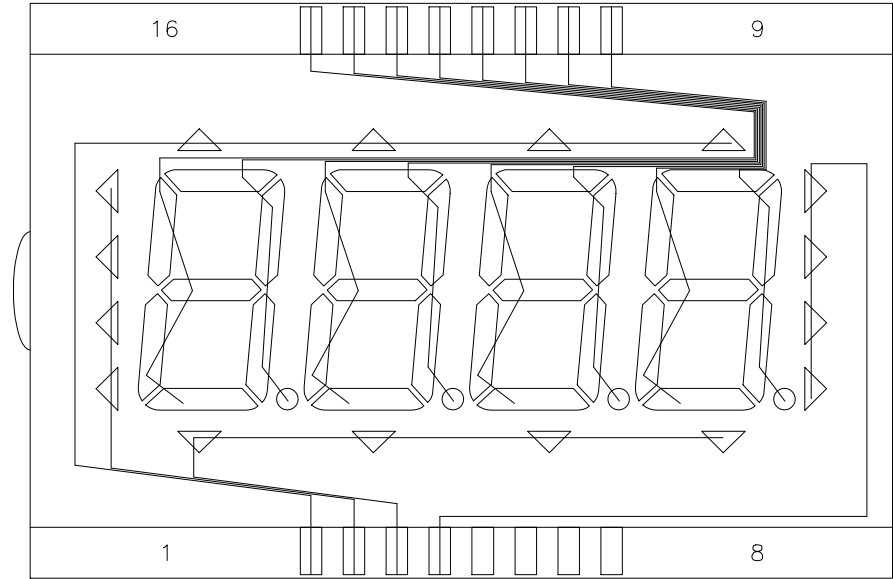

COM

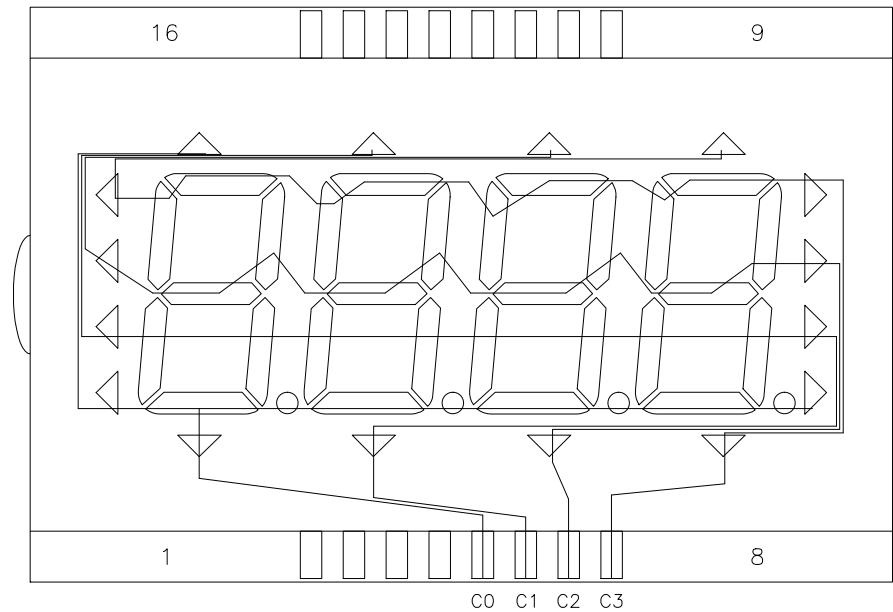

大连奇耘电子有限公司  
DALIAN QIYUN DISPLAY CO., LTD.

DESIGNED BY:

WCL

GDC130S(T)P8V3B

VERSION: 1.0

NO. 3 OF 4

CHECKED BY:

HQM

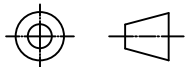

UNIT: mm

DATE: 2016-03-10

TOLERANCES UNLESS OTHERWISE SPECIFIED: ±0.2

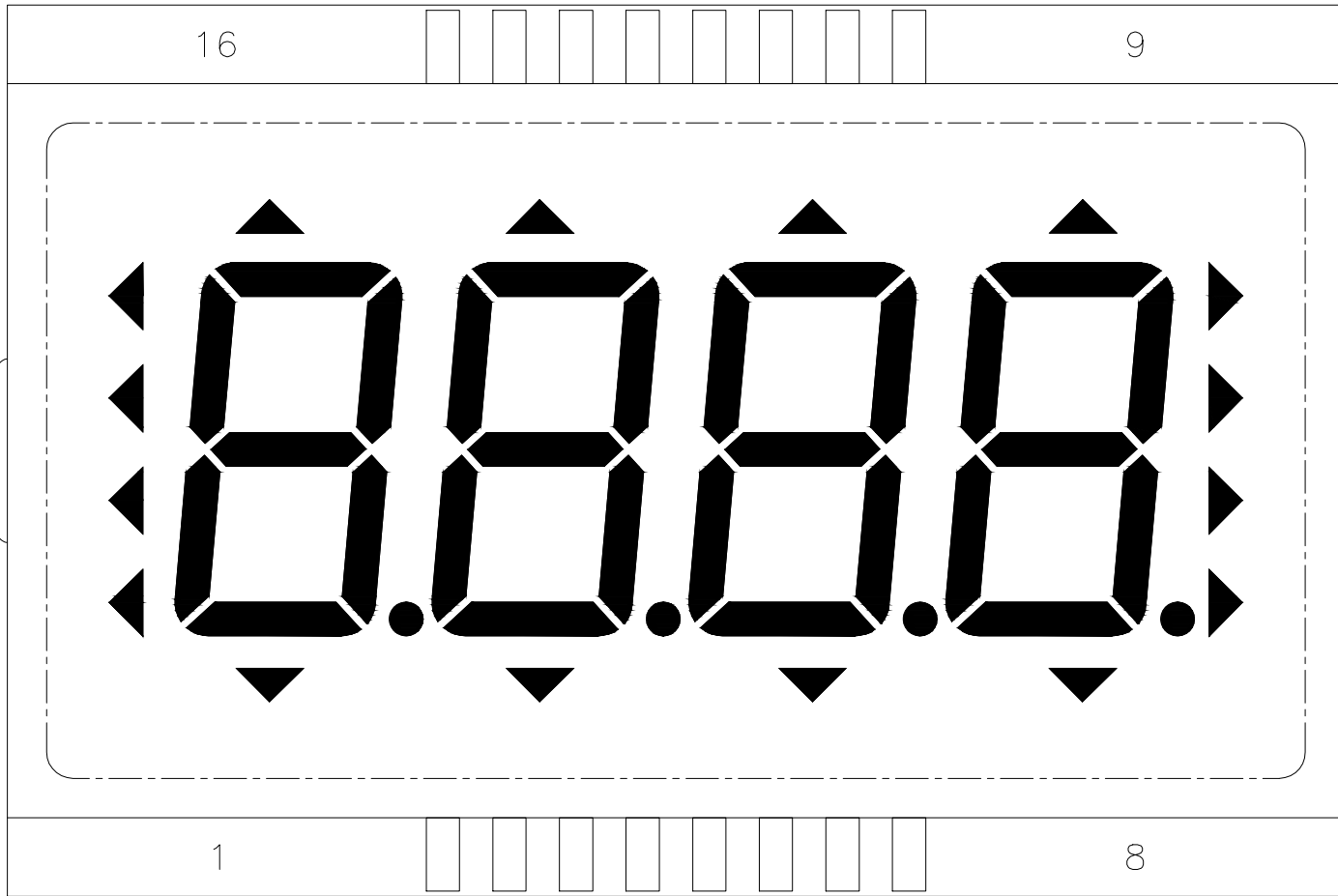

大连奇耘电子有限公司  
DALIAN QIYUN DISPLAY CO., LTD.

DESIGNED BY: <b>WCL</b>	GDC130S(T)P8V3B	VERSION: 1.0
CHECKED BY: <b>HQM</b>		NO. 4 OF 4
		UNIT: mm
TOLERANCES UNLESS OTHERWISE SPECIFIED: ±0.2		DATE: 2016-03-10

全显示效果图