



大连奇耘电子有限公司
DALIAN QIYUN DISPLAY CO., LTD.

DESIGNED BY:

ZN

EDC190S(T)P6.5V3B

VERSION: 1.0

NO. 2 OF 4

CHECKED BY:

HQM

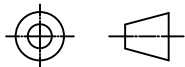

UNIT: mm

DATE: 2015-08-25

TOLERANCES UNLESS OTHERWISE SPECIFIED: ±0.2

全显示效果图

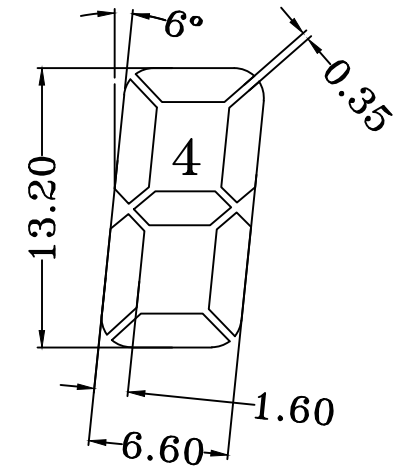
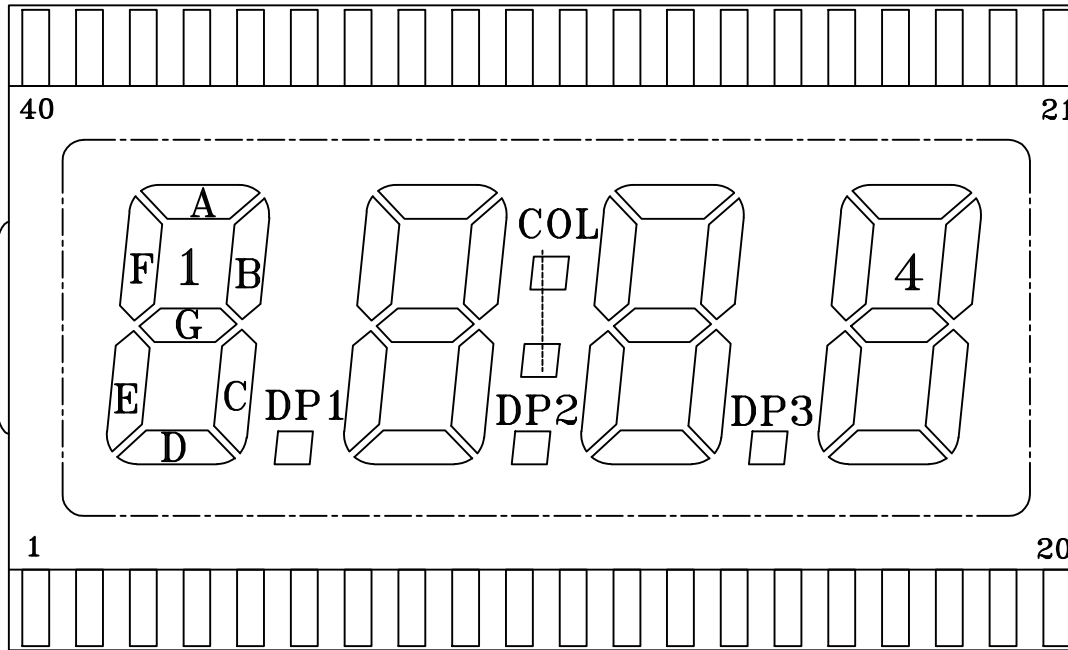

PIN	1	2	3	4	5	6	7	8	9	10	11	12	13	14
COM	COM	/	/	/	1E	1D	1C	DP1	2E	2D	2C	DP2	3E	3D
PIN	15	16	17	18	19	20	21	22	23	24	25	26	27	28
COM	3C	DP3	4E	4D	4C	4B	4A	4F	4G	3B	3A	3F	3G	COL
PIN	29	30	31	32	33	34	35	36	37	38	39	40		
COM	2B	2A	2F	2G	/	1B	1A	1F	1G	/	/	COM		



大连奇耘电子有限公司
DALIAN QIYUN DISPLAY CO., LTD.

DESIGNED BY:

ZN

EDC190S(T)P6.5V3B

VERSION: 1.0

NO. 3 OF 4

CHECKED BY:

HQM

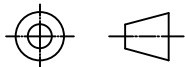

UNIT: mm

DATE: 2015-08-25

TOLERANCES UNLESS OTHERWISE SPECIFIED: ±0.2

SEG

此页图案仅供走线参考!

COM

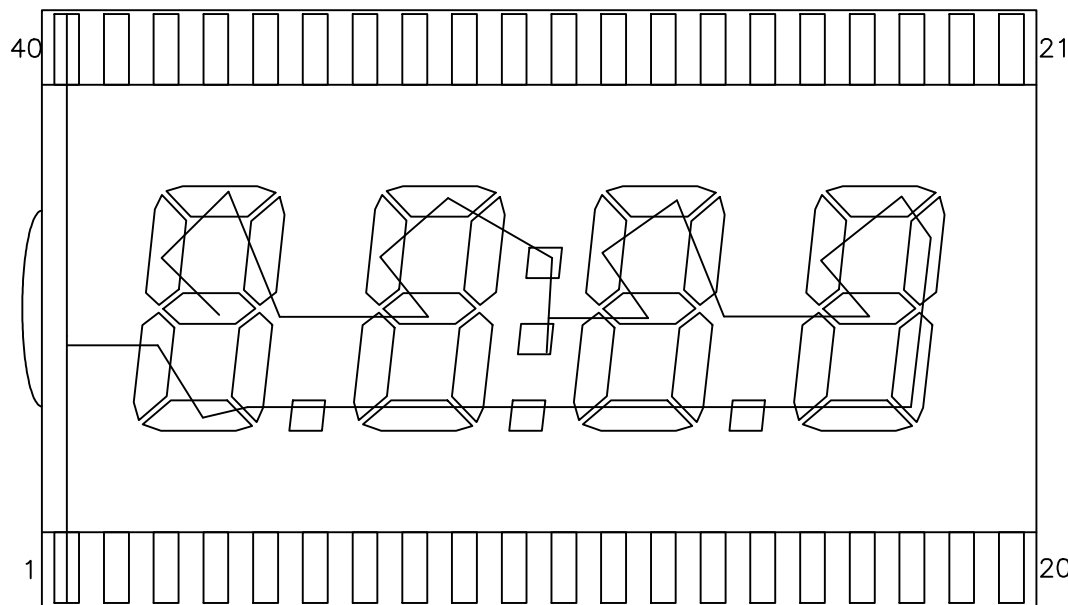
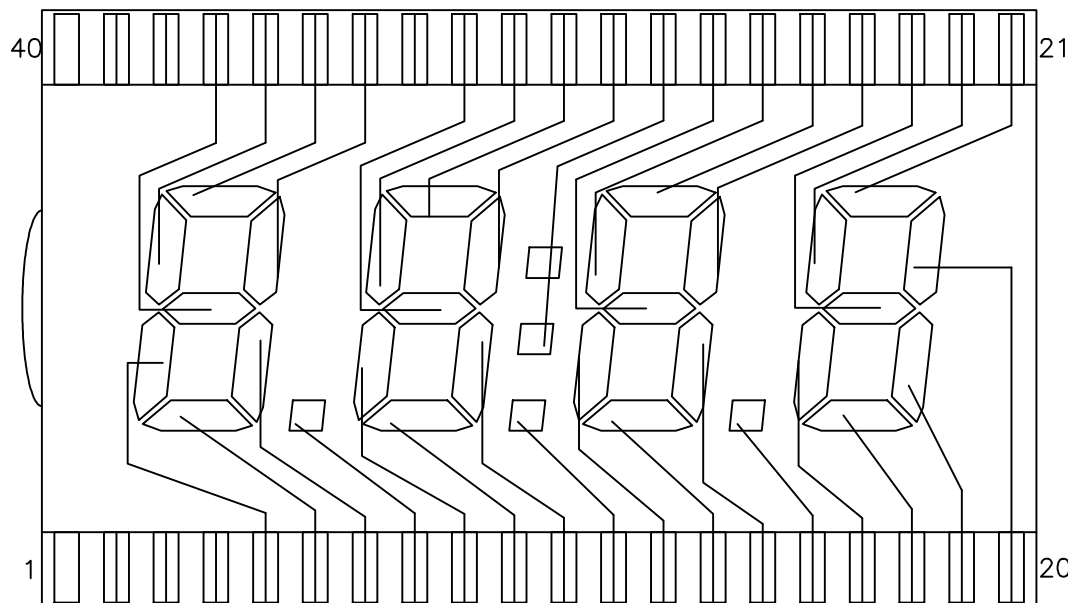

大连奇耘电子有限公司
DALIAN QIYUN DISPLAY CO., LTD.

DESIGNED BY:

ZN

EDC190S(T)P6.5V3B

VERSION: 1.0

NO. 4 OF 4

CHECKED BY:

HQM

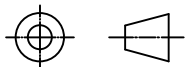

UNIT: mm

DATE: 2015-08-25

TOLERANCES UNLESS OTHERWISE SPECIFIED: ±0.2