

大连奇耘电子有限公司
DALIAN QIYUN DISPLAY CO., LTD.

确认此型号所有图纸;签字确认:

DESIGNED BY: ZN	GDC0689S(T)P10V3B	VERSION: 1.0 NO. 1 OF 4	1. DISPLAY TYPE: HTN/POSITIVE	6. POLARIZER TYPE: TRANSLUCENT	VERSION	REVISION RECORD
CHECKED BY: HQM		UNIT: mm DATE: 2014-08-21	2. OPERATING VOLTAGE: 3.0V	7. VIEWING DIRECTION: 6:00	1.0	初版
TOLERANCES UNLESS OTHERWISE SPECIFIED: ±0.2			3. DRIVE MODE: 1/4DUTY, 1/3BIAS	8. CONNECTOR: PIN	2.0	
			4. OPERATING TEMP: -40°C~85°C	9. CUSTOMER NO:	3.0	
			5. STORAGE TEMP: -45°C~85°C	10. LCM NO:	4.0	

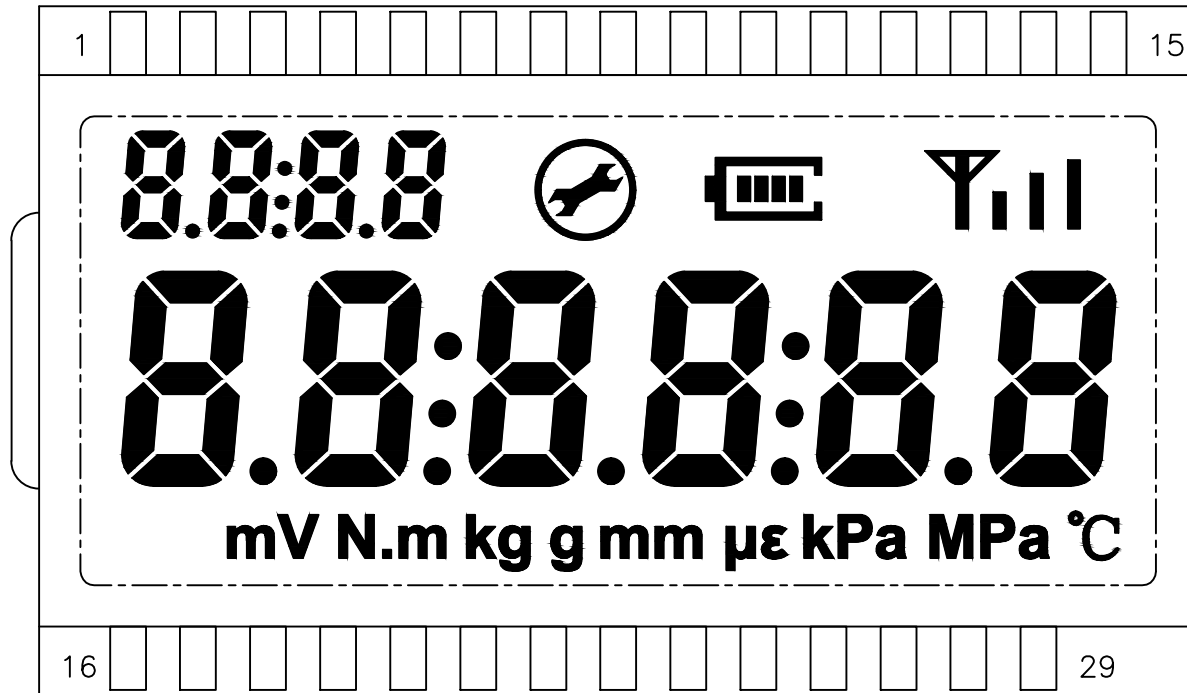

大连奇耘电子有限公司
DALIAN QIYUN DISPLAY CO., LTD.

DESIGNED BY:

ZN

GDC0689S(T)P10V3B

VERSION: 1.0

NO. 2 OF 4

CHECKED BY:

HQM

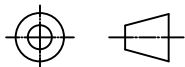

UNIT: mm

DATE: 2014-08-21

TOLERANCES UNLESS OTHERWISE SPECIFIED: ±0.2

全显示效果图

PIN	1	2	3	4	5	6	7	8	9	10	11	12	13	14	15
COM1	1D	DP1	2D	DP2	3D	DP3	4D	COL1	COL2	W5	L1	COM1			
COM2	1E	1C	2E	2C	3E	3C	4E	4C	COL3	W4	L2		COM2		
COM3	1G	1B	2G	2B	3G	3B	4G	4B	T1	W3	L3			COM3	
COM4	1F	1A	2F	2A	3F	3A	4F	4A	W1	W2	L4				COM4

PIN	16	17	18	19	20	21	22	23	24	25	26	27	28	29
COM1	5F	5A	6F	6A	7F	7A	S4	S5	8F	8A	9F	9A	10F	10A
COM2	5G	5B	6G	6B	7G	7B	S3	S6	8G	8B	9G	9B	10G	10B
COM3	5E	5C	6E	6C	7E	7C	S2	S7	8E	8C	9E	9C	10E	10C
COM4	5D	DP5	6D	DP6	7D	DP7	S1	S8	8D	DP8	9D	DP9	10D	S9

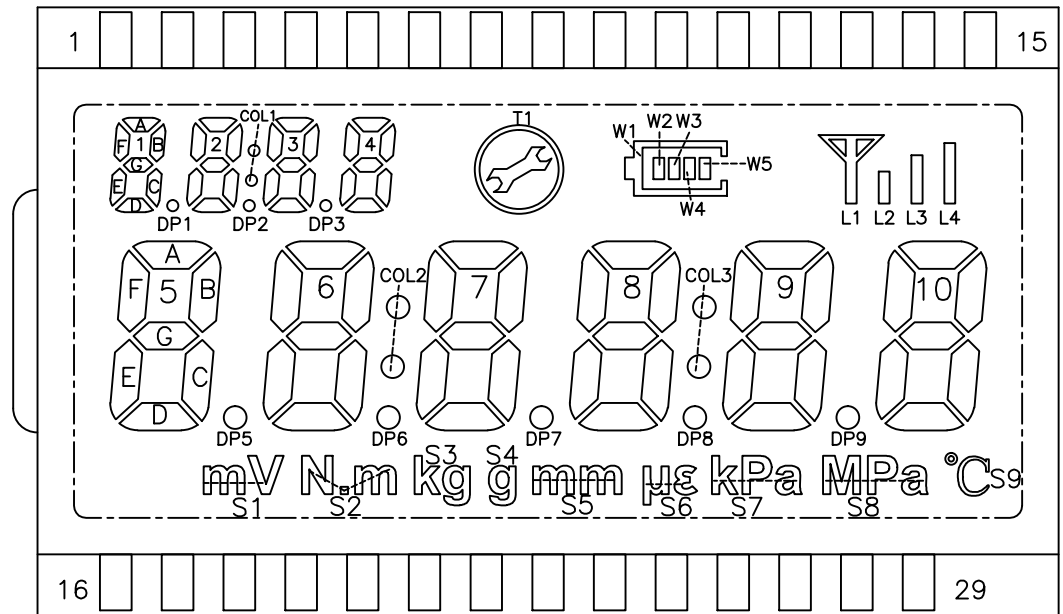

大连奇耘电子有限公司
DALIAN QIYUN DISPLAY CO., LTD.

DESIGNED BY:

ZN

GDC0689S(T)P10V3B

VERSION: 1.0

NO. 3 OF 4

CHECKED BY:

HQM

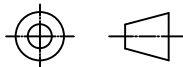

UNIT: mm

DATE: 2014-08-21

TOLERANCES UNLESS OTHERWISE SPECIFIED: ±0.2

SEG

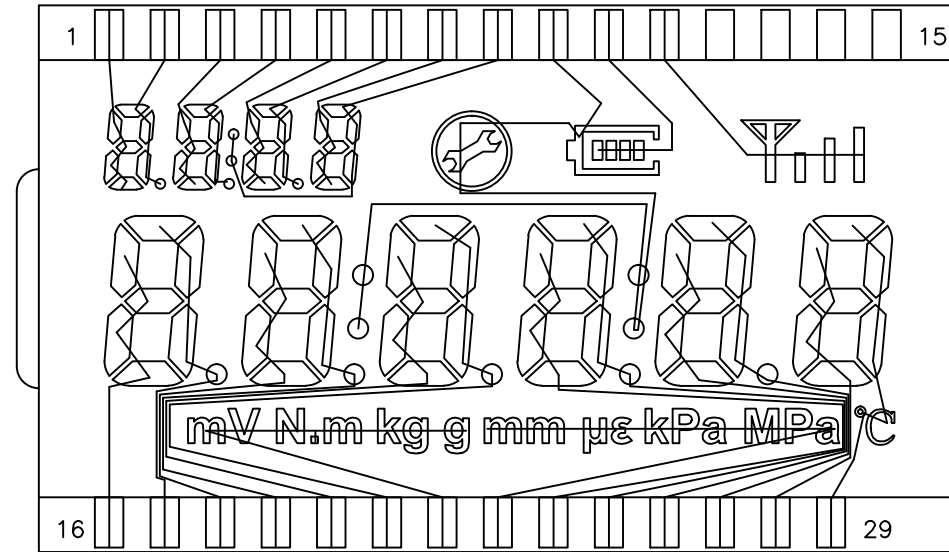

COM

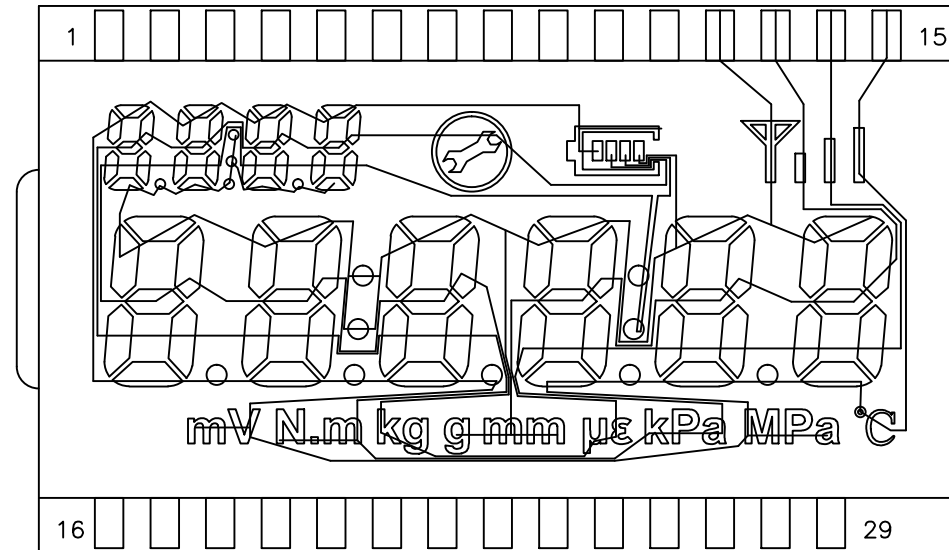

大连奇耘电子有限公司
DALIAN QIYUN DISPLAY CO., LTD.

DESIGNED BY:

ZN

GDC0689S(T)P10V3B

VERSION: 1.0

NO. 4 OF 4

CHECKED BY:

HQM

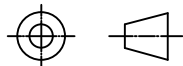

UNIT: mm

DATE: 2014-08-21

TOLERANCES UNLESS OTHERWISE SPECIFIED: ±0.2