

VIEWING DIRECTION

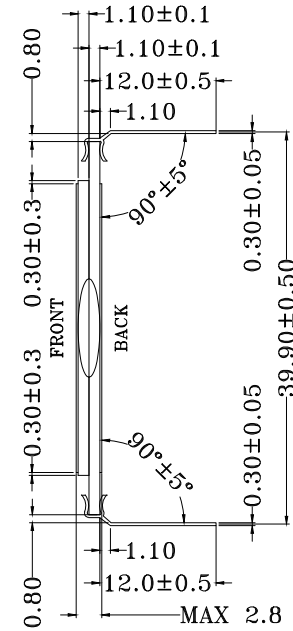
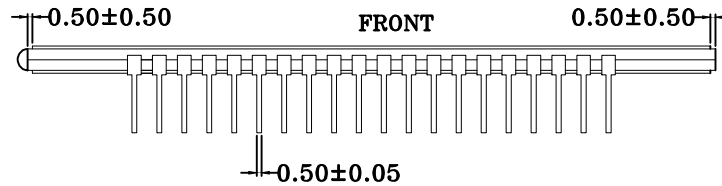

大连奇耘电子有限公司
DALIAN QIYUN DISPLAY CO., LTD.

确认此型号所有图纸;签字确认:

| | | | | | | |
|--|-------------------------|------------------|-------------------------------|----------------------------------|---------|-----------------|
| DESIGNED BY: HTX | EDS815S(T)P12V5B | VERSION: 3.0 | 1. DISPLAY TYPE: TN/POSITIVE | 6. POLARIZER TYPE: TRANSFLECTIVE | VERSION | REVISION RECORD |
| CHECKED BY: WCZ | | NO. 1 OF 4 | 2. OPERATING VOLTAGE: 5.0V | 7. VIEWING DIRECTION: 6:00 | 1. | 初版 |
| | | UNIT: mm | 3. DRIVE MODE: STATIC | 8. CONNECTOR: PIN | 2. | 改电压 |
| | | DATE: 2021-09-13 | 4. OPERATING TEMP: -30°C~80°C | 9. CUSTOMER NO: | 3. | 改半透 |
| TOLERANCES UNLESS OTHERWISE SPECIFIED:±0.2 | | | 5. STORAGE TEMP: -40°C~90°C | 10. LCM NO: | 4. | |

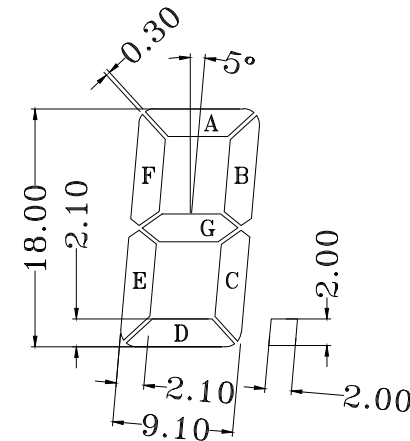
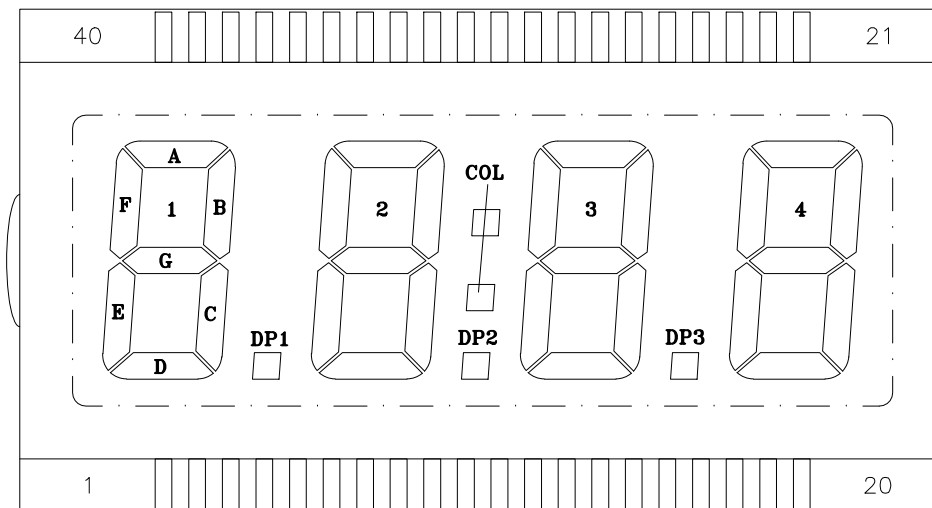

| | | | | | | | | | | | | | | |
|-----|-----|-----|----|----|----|----|----|-----|----|----|----|-----|----|-----|
| PIN | 1 | 2 | 3 | 4 | 5 | 6 | 7 | 8 | 9 | 10 | 11 | 12 | 13 | 14 |
| COM | COM | | | | 1E | 1D | 1C | DP1 | 2E | 2D | 2C | DP2 | 3E | 3D |
| PIN | 15 | 16 | 17 | 18 | 19 | 20 | 21 | 22 | 23 | 24 | 25 | 26 | 27 | 28 |
| COM | 3C | DP3 | 4E | 4D | 4C | 4B | 4A | 4F | 4G | 3B | 3A | 3F | 3G | COL |
| PIN | 29 | 30 | 31 | 32 | 33 | 34 | 35 | 36 | 37 | 38 | 39 | 40 | | |
| COM | 2B | 2A | 2F | 2G | | 1B | 1A | 1F | 1G | | | COM | | |



大连奇耘电子有限公司
DALIAN QIYUN DISPLAY CO., LTD.

DESIGNED BY:

HTX

EDS815S(T)P12V5B

VERSION: 3.0

NO. 2 OF 4

CHECKED BY:

WCZ

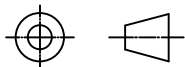

UNIT: mm

DATE: 2021-09-13

TOLERANCES UNLESS OTHERWISE SPECIFIED: ±0.2

SEG

此页图案仅供走线参考!

COM

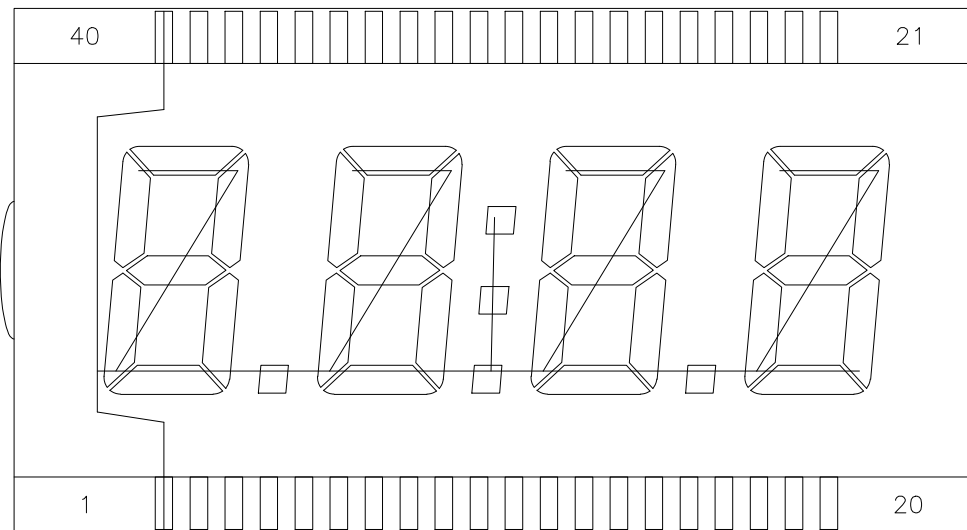
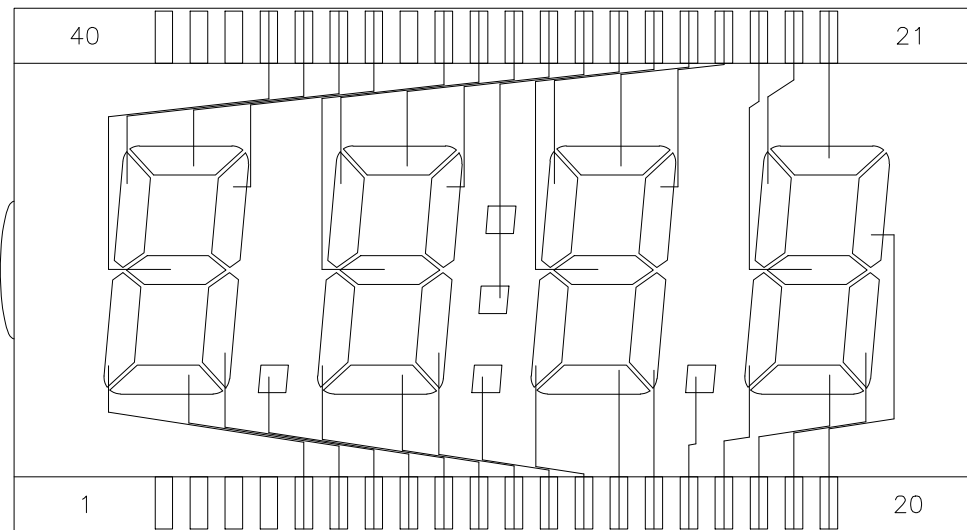

大连奇耘电子有限公司
DALIAN QIYUN DISPLAY CO., LTD.

DESIGNED BY:

HTX

EDS815S(T)P12V5B

VERSION: 3.0

NO. 3 OF 4

CHECKED BY:

WCZ

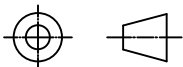

UNIT: mm

DATE: 2021-09-13

TOLERANCES UNLESS OTHERWISE SPECIFIED:±0.2

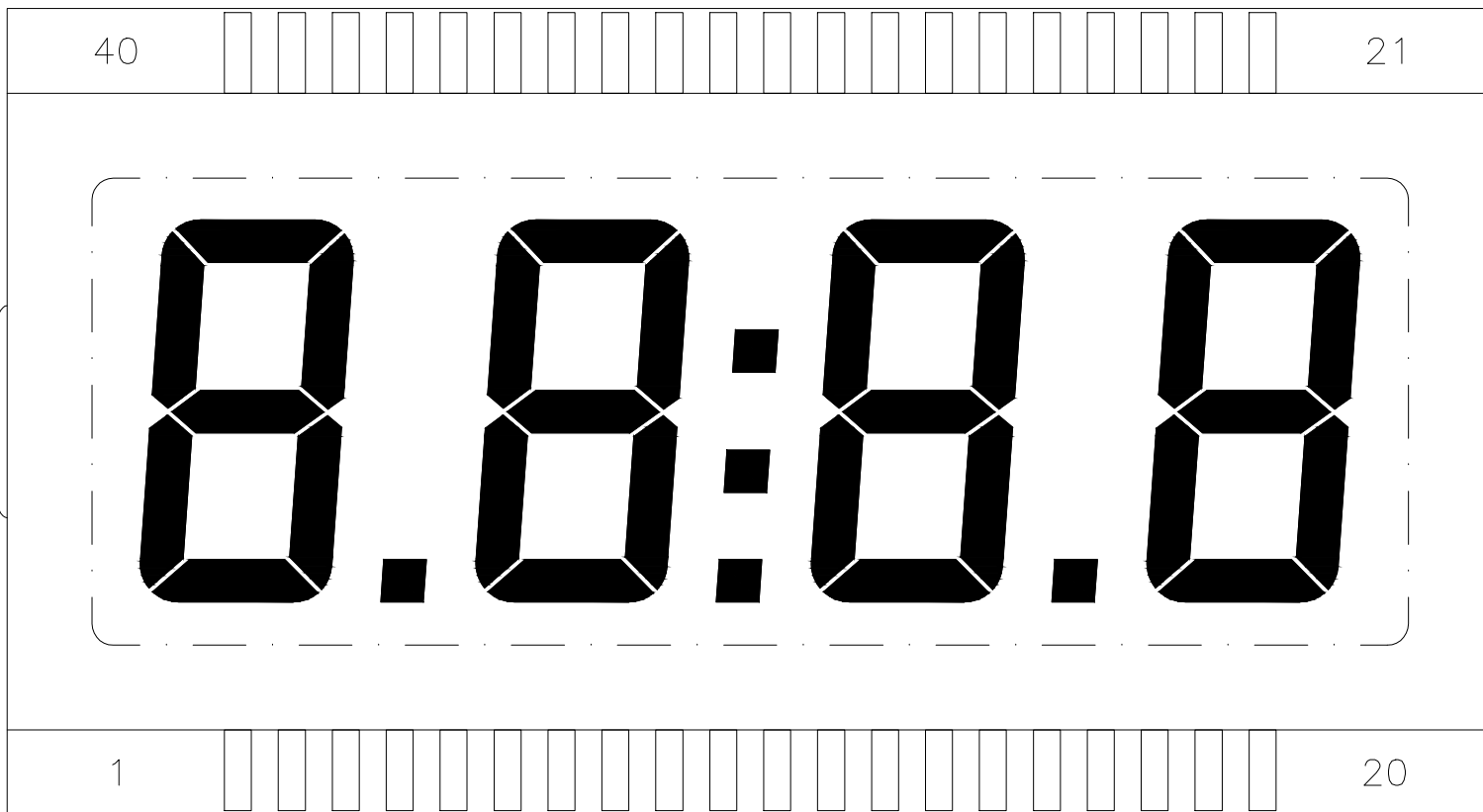

大连奇耘电子有限公司
DALIAN QIYUN DISPLAY CO., LTD.

| | | |
|---|-------------------------|------------------|
| DESIGNED BY: HTX | EDS815S(T)P12V5B | VERSION: 3.0 |
| CHECKED BY: WCZ | | NO. 4 OF 4 |
| | | UNIT: mm |
| | | DATE: 2021-09-13 |
| TOLERANCES UNLESS OTHERWISE SPECIFIED: ±0.2 | | |

全显示效果图