

大连奇耘电子有限公司  
DALIAN QIYUN DISPLAY CO., LTD.

确认此型号所有图纸;签字确认:

DESIGNED BY: G J	EDS809-1(T)P8V3B	VERSION: 2.0 NO. 1 OF 4	1. DISPLAY TYPE: TN/POSITIVE	2. OPERATING VOLTAGE: 3.0V	3. DRIVE MODE: 1/4DUTY,1/3BIAS	4. OPERATING TEMP: -10°C~60°C	5. STORAGE TEMP: -20°C~70°C	6. POLARIZER TYPE: TRANSLFLECTIVE	7. VIEWING DIRECTION: 6:00	8. CONNECTOR: PIN	9. CUSTOMER NO:	10. LCM NO:	VERSION 1.0 2.0 3.0 4.0	REVISION RECORD 初版 反射改半透
CHECKED BY: HQM		UNIT: mm DATE: 2019-5-19												
TOLERANCES UNLESS OTHERWISE SPECIFIED:±0.2														

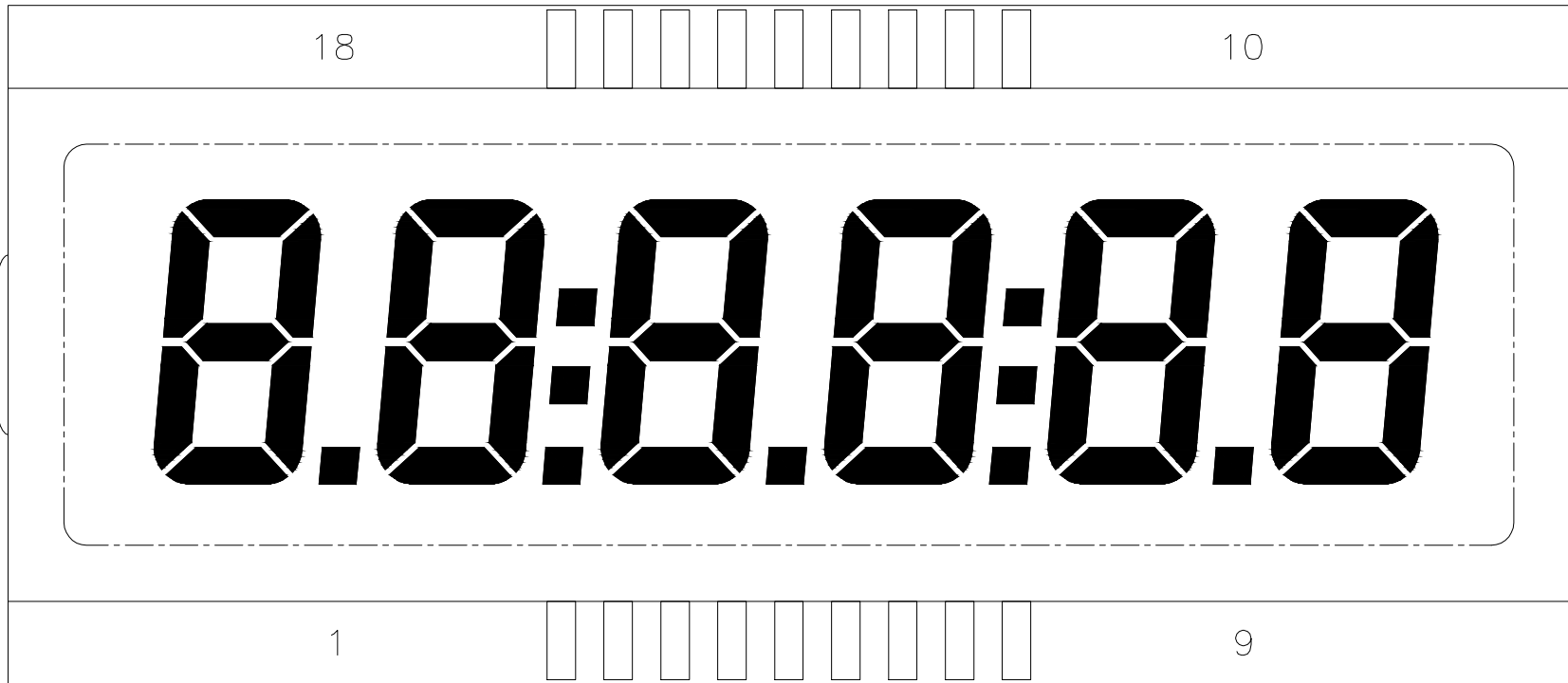

大连奇耘电子有限公司  
DALIAN QIYUN DISPLAY CO., LTD.

DESIGNED BY:

G J

EDS809-1(T)P8V3B

VERSION: 2.0

NO. 2 OF 4

CHECKED BY:

HQM

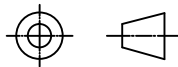

UNIT: mm

DATE: 2019-5-19

TOLERANCES UNLESS OTHERWISE SPECIFIED: ±0.2

全显示效果图

PIN	1	2	3	4	5	6	7	8	9	10	11	12	13	14	15	16	17	18
COM1	COM1					5F	5A	6F	6A	4A	4F	3A	3F	COL1	2A	2F	1A	1F
COM2		COM2				5G	5B	6G	6B	4B	4G	3B	3G		2B	2G	1B	1G
COM3			COM3			5E	5C	6E	6C	4C	4E	3C	3E		2C	2E	1C	1E
COM4				COM4	COL2	5D	DP5	6D		DP4	4D	DP3	3D		DP2	2D	DP1	1D

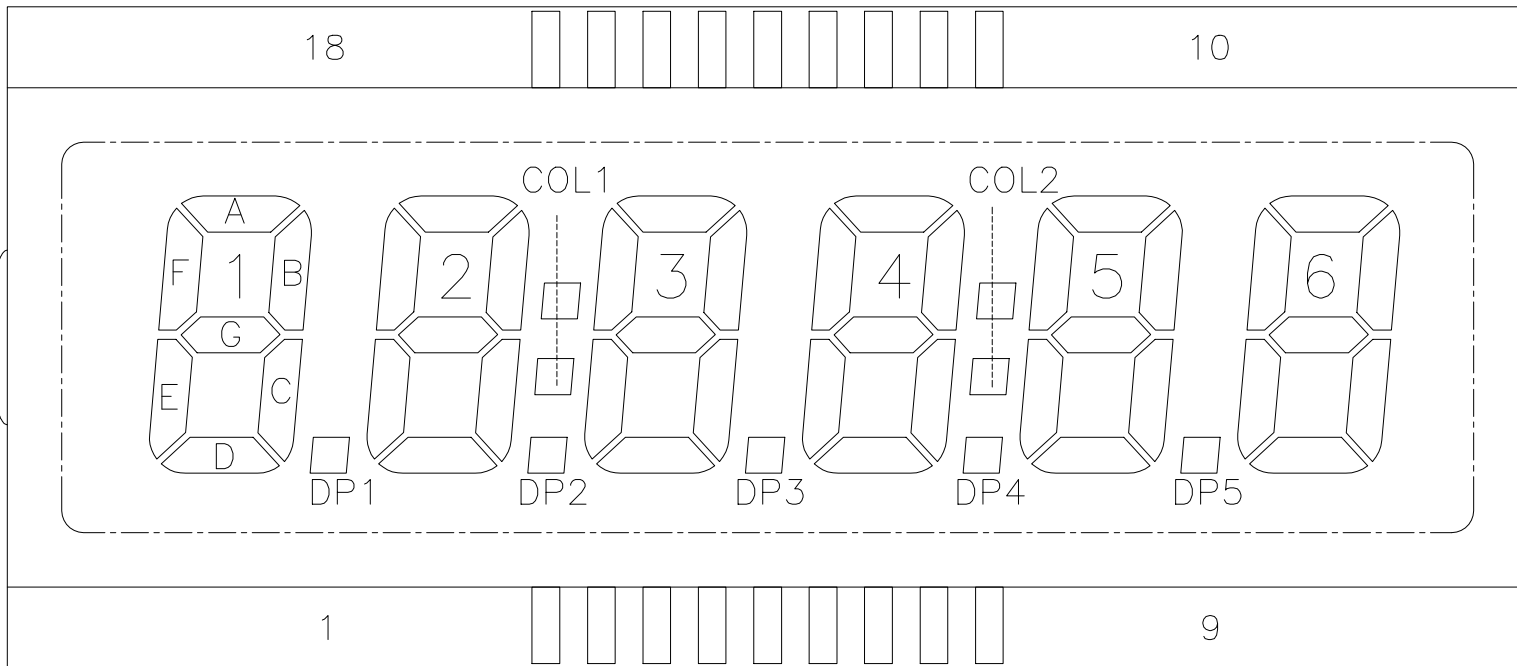

大连奇耘电子有限公司  
DALIAN QIYUN DISPLAY CO., LTD.

DESIGNED BY:

G J

EDS809-1(T)P8V3B

VERSION: 2.0

NO. 3 OF 4

CHECKED BY:

HQM

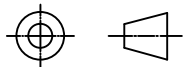

UNIT: mm

DATE: 2019-5-19

TOLERANCES UNLESS OTHERWISE SPECIFIED: ±0.2

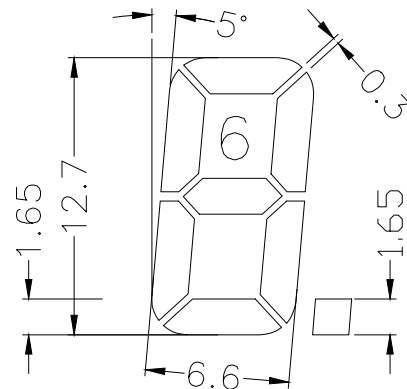

SEG

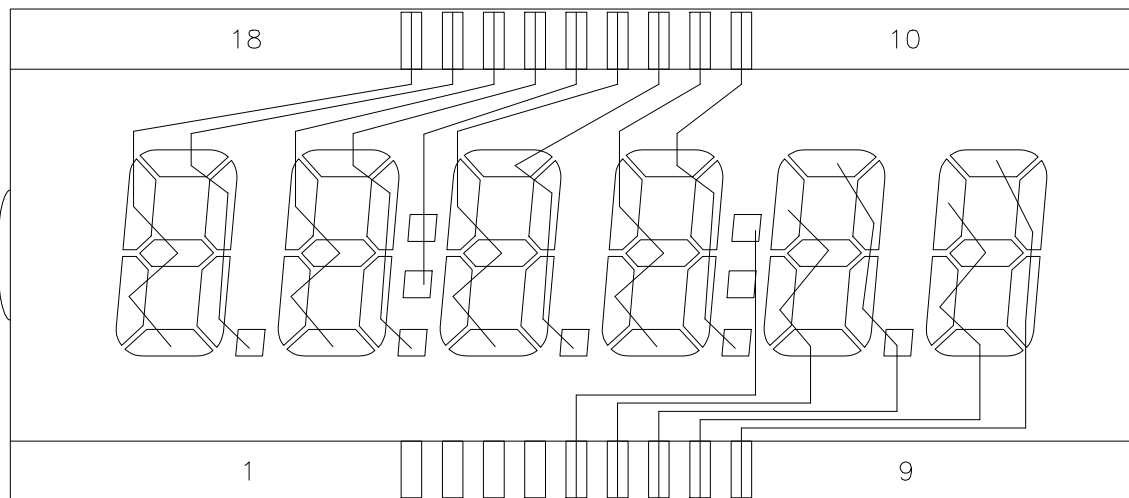

COM

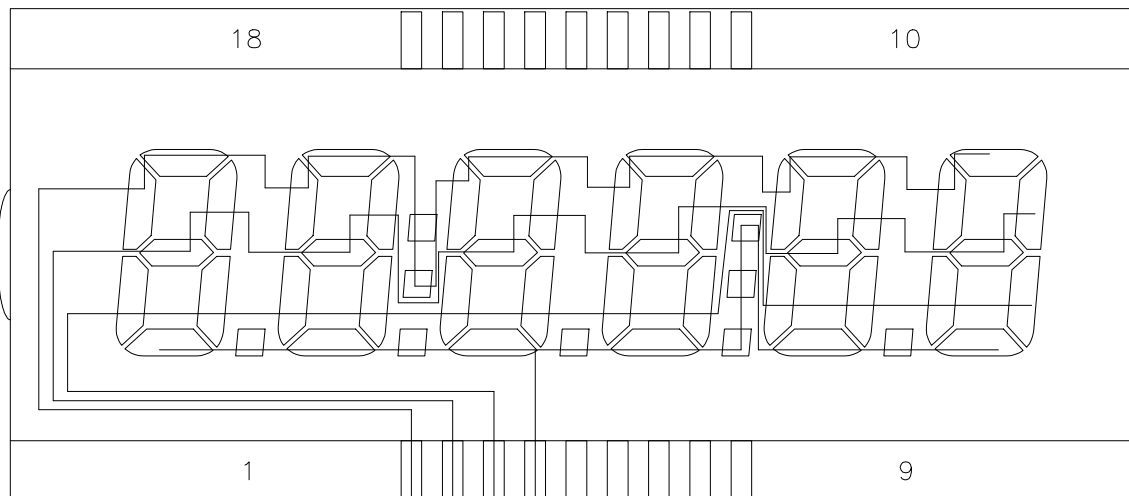

大连奇耘电子有限公司  
DALIAN QIYUN DISPLAY CO., LTD.

DESIGNED BY:

G J

EDS809-1(T)P8V3B

VERSION: 2.0

NO. 4 OF 4

CHECKED BY:

HQM

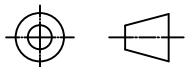

UNIT: mm

DATE: 2019-5-19

TOLERANCES UNLESS OTHERWISE SPECIFIED: ±0.2