

OpenPIC Pro development board Schematic(20240512)

Hardware Revision v2  
 If you are experiencing some problems with any of our products or just need additional information, please contact our technical support: [microhello\\_sales@163.com](mailto:microhello_sales@163.com)  
 If you want to learn more about our product, please visit our website: [www.MicroHello.com](http://www.MicroHello.com)

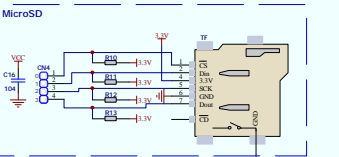
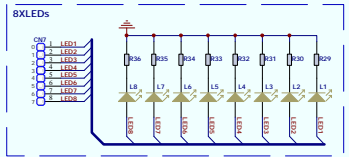
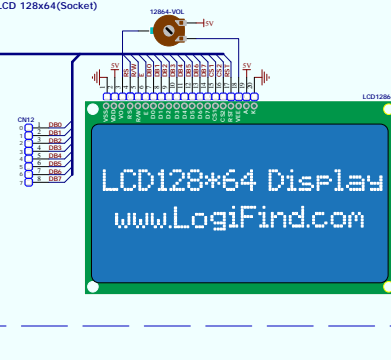
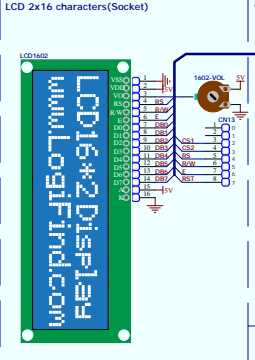
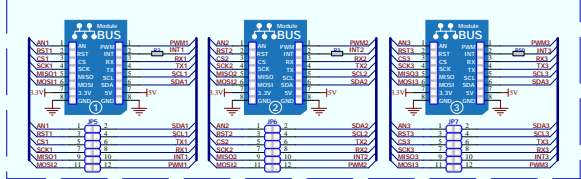
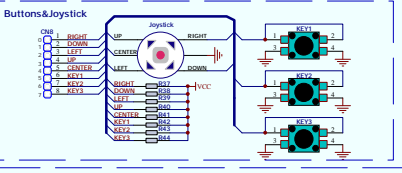
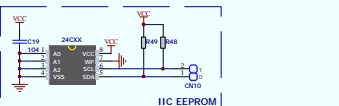
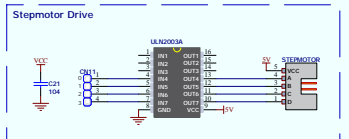
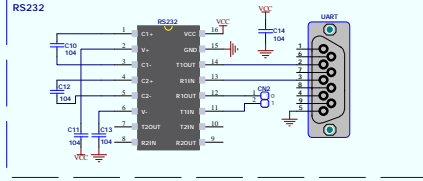
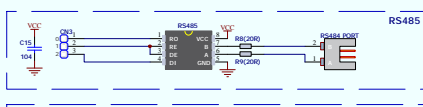
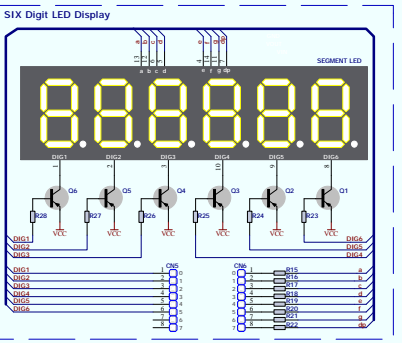
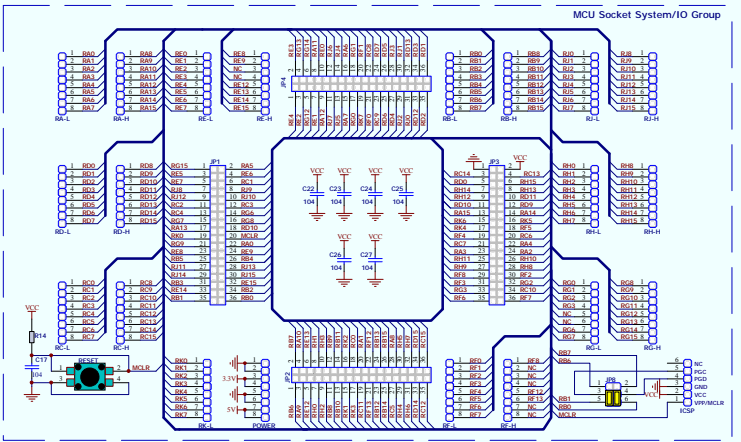
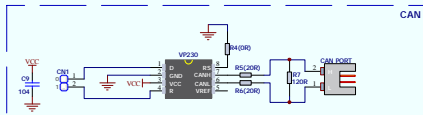

|       |                                   |          |  |
|-------|-----------------------------------|----------|--|
| Title |                                   | Revision |  |
| Size  | Number                            |          |  |
| A1    |                                   |          |  |
| Date  | 17 Jun 2025                       | Sheet of |  |
| File  | F:\pic16f1887\16F1887-Desain\2024 | Drawn by |  |