

CARD80-PIC-A development board(Can be used on OpenMCU Basic-A) Schematic

Hardware Revision v2

If you are experiencing some problems with any of our products or just need additional information, please contact our technical support: wx107297662156@163.com

If you want to learn more about our product, please visit our website:

www.MicroHello.com

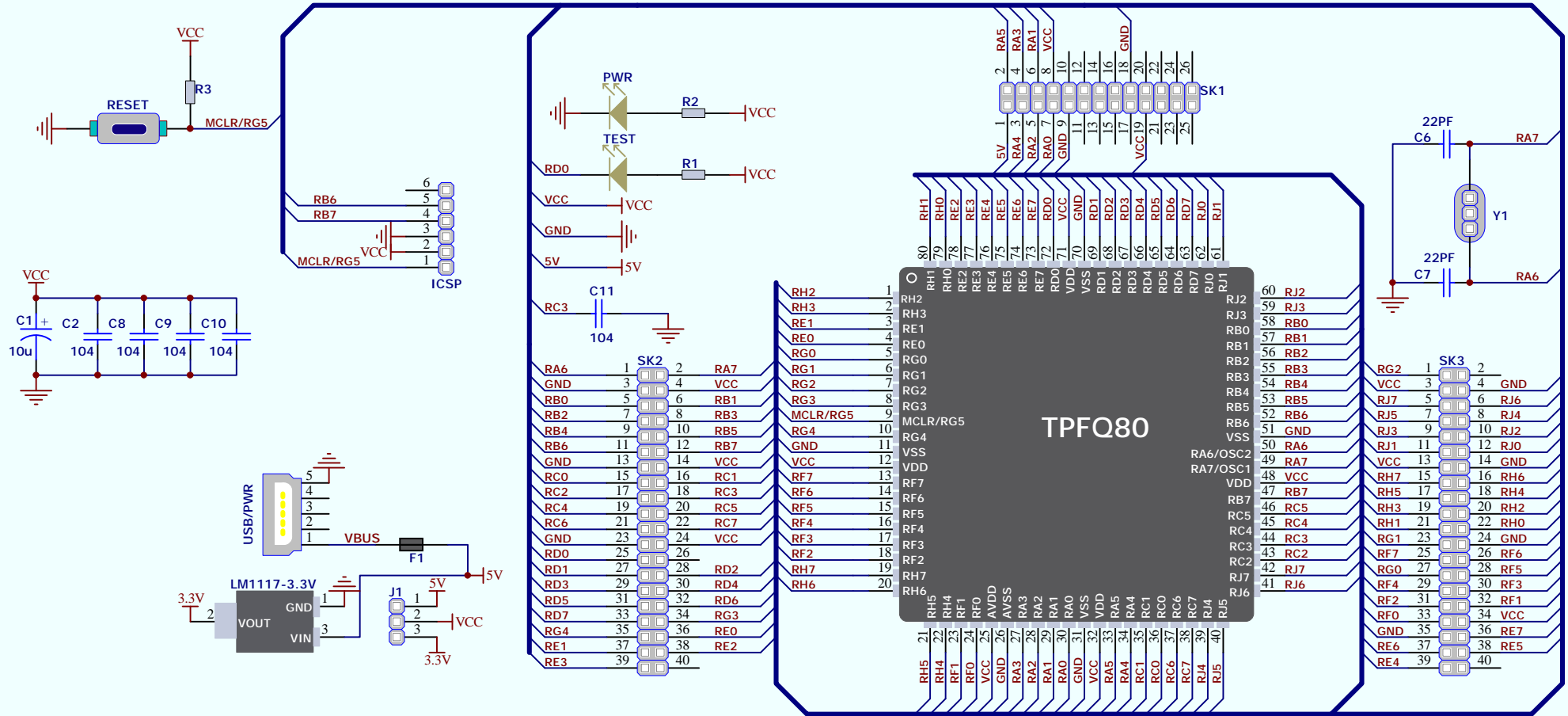

Title		
Size	Number	Revision
A4		
Date:	24-Apr-2024	Sheet of
File:	E:\prote1电路设计\LogiFind_Design20220108.Ddwn By:	